



Putzmeister

PLACING SYSTEMS

PLACING SYSTEMS



PUTZMEISTER PLACING SYSTEMS GIVE YOU TOTAL BOOM VERSATILITY, ALLOWING YOU TO TAKE ON MORE JOBS THAN YOU THOUGHT POSSIBLE. EVEN EXTREME APPLICATIONS CAN BE EASILY TACKLED.

Our complete line of placing systems, from our placing booms and modular towers to our detach kit and accessories, maximize your truck-mounted boom flexibility and provide extra avenues of revenue generation.

With placing booms, you can place concrete faster, more uniformly and with pinpoint accuracy. Just as important, Putzmeister placing systems can help you save time and money with the quickest and easiest truck-to-tower conversions, while promoting job safety and contractor flexibility.

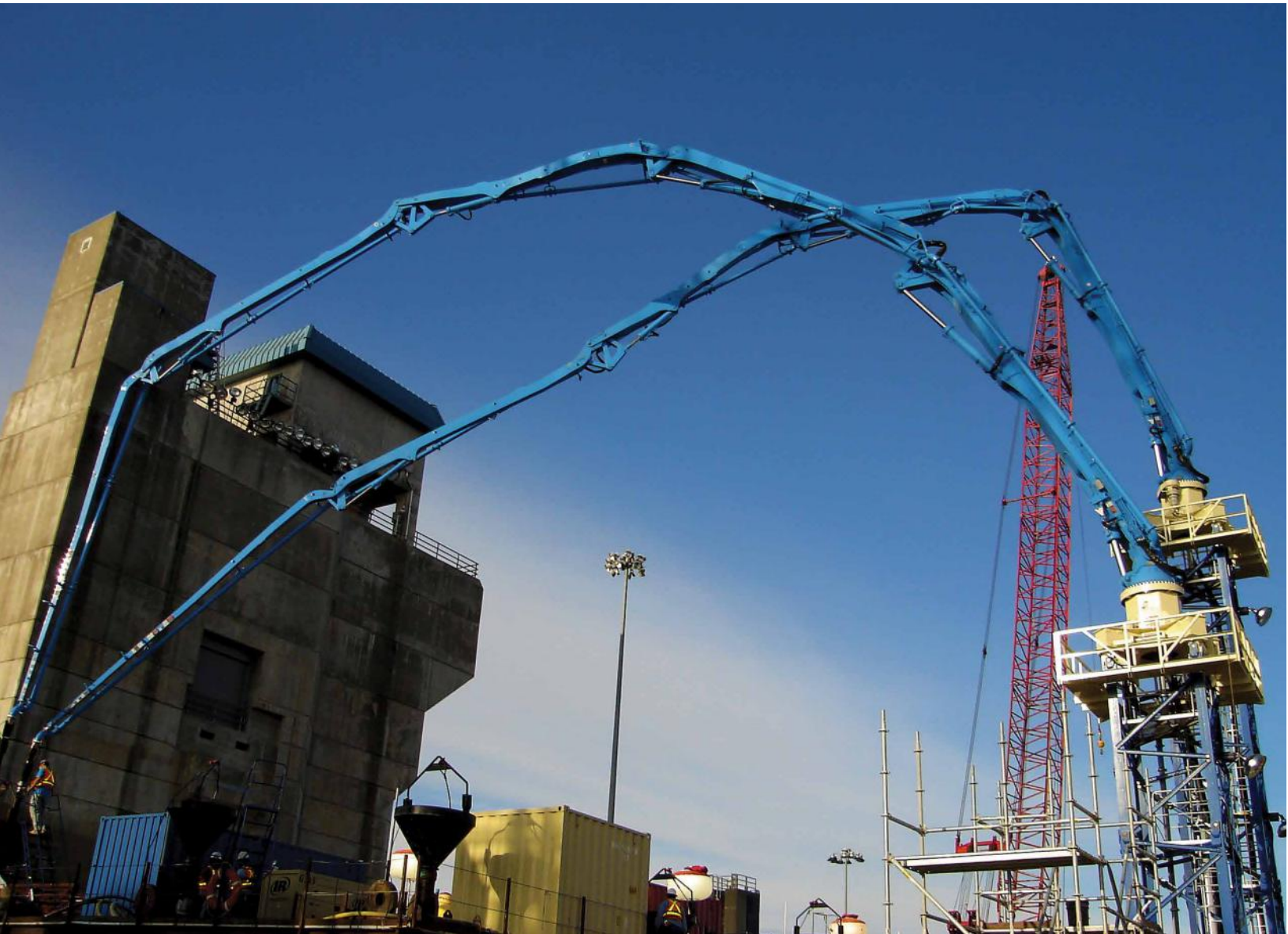

PUTZMEISTER PLACING SYSTEMS

COMPLETE SYSTEM SUPPORT FROM START TO FINISH

At Putzmeister, we take a complete systems approach to your jobs. Our specialists work with you from the inception of a project to completion, including specifying equipment, consulting on concrete composition, and designing a system for maximum placing coverage. And whatever your equipment needs – from placing booms, towers and mounting and climbing configurations, to trailer pumps, boom pipes, gate and diversion valves and more – our comprehensive product line has you covered.

Through Putzmeister America, Inc.'s Special Applications Business (SAB), the complete systems approach is realized. We offer you all products to all projects in concrete delivery and placement. We remain in constant contact with you from the estimating stages of a project, to working with you on delivery times, customizing confidential solutions for unique scenarios, service, parts and training, as well as maintenance of equipment.

But we don't stop there, the support continues. We're there to support contractors by supplying information on unit placement, offering technical data, and ensuring our equipment performs to specifications. Putzmeister technicians are available across the country to help in emergency situations, offer advice and answer questions that arise.

Our local subsidiaries and qualified distributors can also assist with:

- Complete startup support
- Technical assistance
- Classroom and on-site training
- Quick turnarounds on genuine Putzmeister parts – more than 20,000 in stock for next-day delivery
- Warranty work

Our goal is the same as your goal: optimum efficiency on each job in terms of placement and the bottom line.

PLACING SYSTEMS AROUND THE WORLD

Putzmeister placing systems have played a vital role in the construction of these landmarks:

Hoover Dam Bypass

Burj Khalifa

The Wilshire Grand

Oakland – Bay Bridge

Tappan Zee Bridge

Skyline at MacArthur Place

Hydro-Quebec Eastmain – 1 Dam and Power House

New Orleans GIWW Bypass Gate

Trump Ocean Club International Hotel & Tower

Hollywood & Vine – W Hotel & Residence

Tacoma Narrows Bridge

Energia Costa Azul

Wachovia Corporate Center

CityCenter™ Las Vegas



EXCLUSIVE TECHNOLOGY

STANDS TALL

Putzmeister's commitment to innovation has produced the most advanced placing booms available. Our leading-edge engineering has developed many products with unique features that set our equipment apart. For example, our placing systems have the highest freestanding heights in the industry without counterweight.

This exclusive technology helps keep you on top of your jobs.

5



PLACING SYSTEM ADVANTAGE



SIMPLE BRACING WITH VERTICAL SUPPORT

6

Putzmeister's vertical support system firmly supports the tower using aluminum wedges for lateral bracing. This support option is available for use with our pin tower system.



SQUARE TOWER WITH MODULAR DESIGN

7

Putzmeister's modular high-strength square tower easily expands for use at a variety of heights and floor levels. It protects delivery line and power connections inside the tower, makes it easier to block out and patch floor openings, and allows for convenient inside ladder access.



HIGHEST FREESTANDING HEIGHTS

8

Only Putzmeister towers can free stand up to 80 ft. (24m) heights without counterweight – the highest in the industry.



HIGHEST REACH ABOVE UPPER WEDGE POINT

9

With up to a 46 ft. (14m) overhang before it's necessary to raise the boom, we offer the market's greatest height above the upper wedge point. Pour more floors with less jumps using our highly versatile support system.



SPACIOUS PLATFORM

12

Safety-conscious platform allows convenient chest height access to four-pin connection, making setup a breeze. Plus, the platform allows a bird's eye view for the operator.



VERSATILE PEDESTAL

10

Our placing boom and pedestal are separate components so they can be moved together or individually, depending on the capacity of the crane on site. For easy reconnection, just lower the pedestal until the ears hit the lugs. The pedestal precisely aligns itself.



NO COUNTERWEIGHT ON BOOMS

13

No labor intensive and cumbersome counterweight is needed with Putzmeister placing booms, saving time and labor.



EASIEST BOOM TO RAISE AND MOVE

11

Our simple Hydraulic Connection and easy four-pin connection make our boom the easiest to raise and move in the industry. Pick up and move the entire system in under ten minutes.



LIGHTWEIGHT BOOM

14

Our low-weight placing booms provide lighter crane picks and allow the boom to be positioned farther from the crane for greater overall placing coverage. Plus, the highly versatile four-section booms mean more effective reach.

**ALL PLACING BOOM MODELS
PIN CONNECT TO THE SAME
PEDESTAL AND PIN TOWER
SYSTEM FOR UNMATCHED
EASE OF USE.**

EASY DOES IT – EVERY TIME

Putzmeister's Series II Detach Boom is available for MX 24/28Z and MX 36/40Z. Only Putzmeister gives you the flexibility to install the Series II kit on your initial boom pump order, or add at a later date. The Series II kit is the fastest and easiest truck-to-tower conversion in the industry, bringing more efficiency to your time-sensitive jobs and is adaptable to most Putzmeister pumps manufactured after 1985.

The quick detach kit, featuring our exclusive Hydraulic Connection technology, is ideal for situations in which the boom must be frequently transferred. It allows the operator to couple and uncouple individual hydraulic hoses while not under pressure.

To reduce flyweight by 4,850 lbs. (2,220kg), the pedestal can be left on the tower.

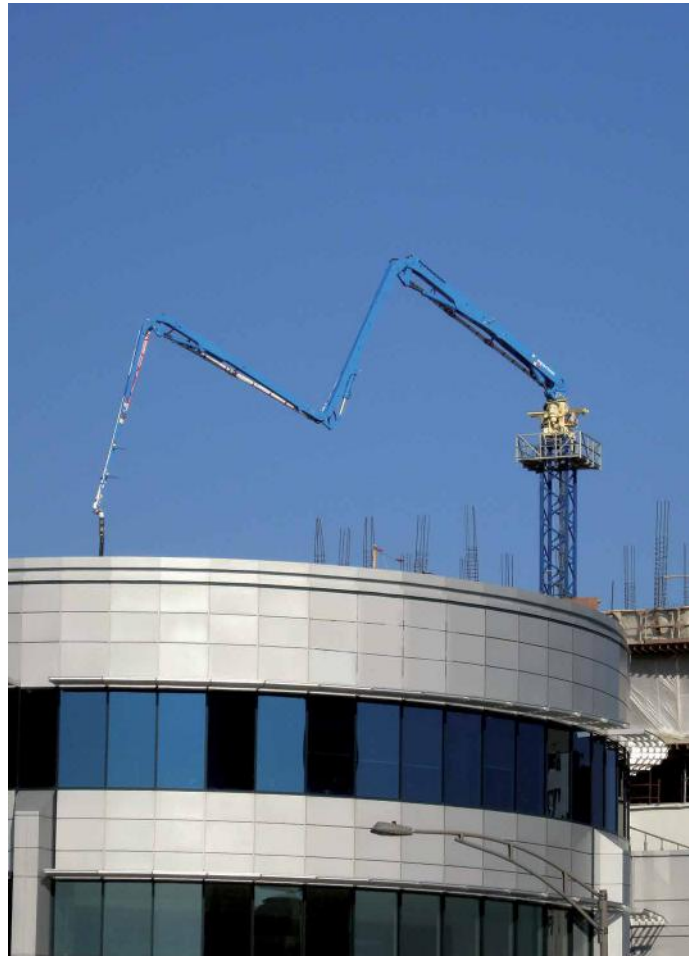

15

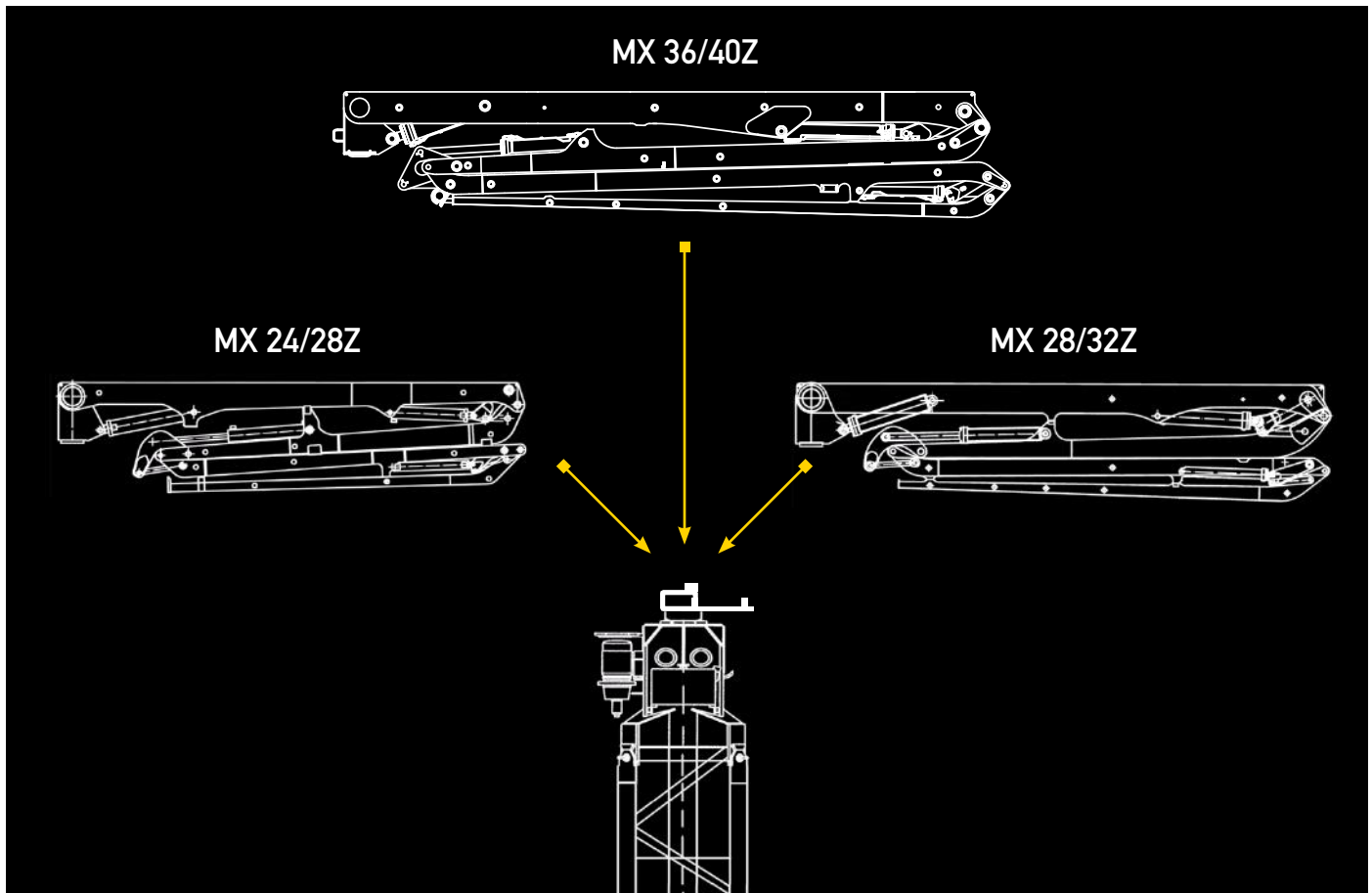

16

MOVE THE BOOM IN FOUR EASY STEPS



STEP 1 – Hydraulic Connection

17



STEP 2 – Detach boom and lift

18



STEP 3 – Fly boom from truck to tower

19



STEP 4 – Position, pin and pump

20

RS 750 PIN CONNECT

Four heavy-duty pins in the pin system permit faster and easier connections when installing or raising the placing boom tower. The pin system gives you the flexibility to choose between a variety of mounting and climbing configurations.



21

MOUNTING AND CLIMBING

VERSATILITY

Years of experience in designing placing systems for countless applications have resulted in Putzmeister's ability to offer an extremely efficient placing boom tower and the widest variety of mounting and climbing configurations.

Whatever your needs, Putzmeister has a system to meet your site's unique requirements.

Climbing

- Inside Climbing
- Hydraulic Climbing
- Universal Tie Frame

Mounting

- Freestanding
- Foundation Base Plate
- Ballasted Base
- Clamp Down Mounting Base
- Adjustable Wall Bracket



C UNIVERSAL TIE FRAME

22

The Universal Tie Frame, sometimes referred to as Outside Tie-In, secures the tower inside or outside the structure.



C INSIDE CLIMBING

23

Supported by the building, the unit easily climbs via crane.



C HYDRAULIC CLIMBING

24

The unit can climb without a crane using two lift cylinders and the pedestal's hydraulics.



M FREESTANDING

25

Only Putzmeister reaches up to 80 ft. (24m) freestanding heights without counterweight.

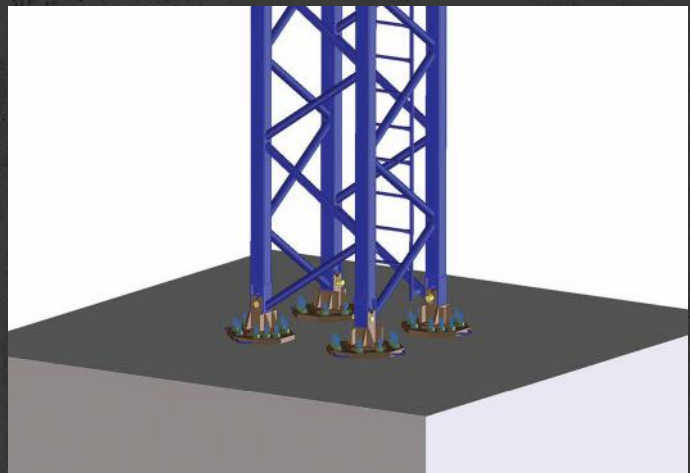

M FOUNDATION BASE PLATE

26

Convenient floor support plates for use with an existing concrete slab.



M CLAMP DOWN MOUNTING BASE

27

Clamps down to an existing structure or form framework. Used with or without a tower.



M BALLASTED BASE

28

An optional kit is available for freestanding applications without a foundation.

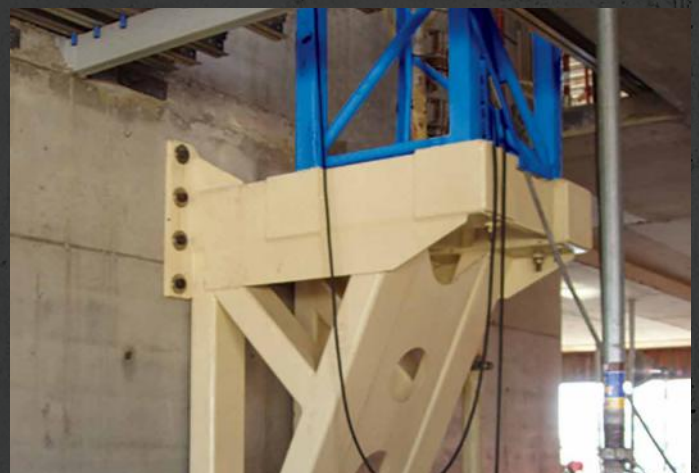

M ADJUSTABLE WALL BRACKET

29

Specially engineered, the wall bracket does not anchor to the forming system, avoiding form vibration.

SPECIALIZING IN CUSTOMIZED APPLICATIONS



30

Ideal for demanding applications, such as high-rise buildings, treatment plants, precast plants, bridges and dams, in addition to decks, walls and columns – Putzmeister's complete line of placing systems give you options to better serve your specialty application requirements.

Our placing systems:

- Large scale booms achieve up to 138' 1" (42.09m)
- Allow for larger pours due to speed and placement and eliminates waste
- Cuts down on size of crew, reduces labor and compresses job schedule
- Frees crane hook time for other tasks
- Promotes safety on deck and allows operator to see placing crew and precisely adjust boom
- Place concrete easily around or over obstacles
- Eliminates shock loading of forms
- Provide minimum separation to promote a smoother finish
- Precast applications
 - Mounts directly to Putzmeister tower anchors on foundation – other mountings possible
 - Uses only 16 sq. ft. (1.5m²) floor space
 - Allows continuous concrete placement into forms
 - Tower protects delivery lines and power connections



31



32

PUTZMEISTER PLACING SYSTEMS SPECIFICATIONS

Reach/Boom	MX 24/28Z	MX 28/32Z	MX 36/40Z
Boom Design	Multi-Z	Multi-Z	Multi-Z
Horizontal Reach	78' 1" (23.80m)	91' 10" (28.00m)	115' 2" (35.10m)
Vertical Reach*	78' 1" (23.80m)	91' 10" (28.00m)	115' 2" (35.10m)
Reach Depth*	71' 10" (21.90m)	80' 9" (24.60m)	93' 10" (28.60m)
Stowed Boom Length	23' 4" (7.11m)	26' 4" (8.04m)	32' 4" (9.85m)
Boom Sections			
1 st Section	22' 8" (7.00m)	25' 11" (7.90m)	30' 10" (9.40m)
2 nd Section	18' 4" (5.59m)	21' 11" (6.70m)	27' 7" (8.40m)
3 rd Section	18' 4" (5.59m)	21' 11" (6.70m)	28' 7" (8.70m)
4 th Section	18' 4" (5.59m)	21' 11" (6.70m)	28' 3" (8.60m)
Boom Articulation			
1 st Section	101°	95°	102°
2 nd Section	180°	180°	180°
3 rd Section	267°	266°	245°
4 th Section	268°	265°	233°
General Specs			
Rotation	365°	365°	365°
Pipeline Diameter	5" (125mm)	5" (125mm)	4.6" (117mm)
Power	400-480V/50-60HZ/35amp	400-480V/50-60HZ/35amp	400-480V/50-60HZ/35amp
Control Systems	Radio-Cable-Manual	Radio-Cable-Manual	Radio-Cable-Manual
Weights			
Boom Weight	8,713 lbs (3,952kg)	12,591 lbs (5,711kg)	13,144 lbs (5,962kg)
Pedestal Weight	4,850 lbs (2,200kg)	4,850 lbs (2,200kg)	4,850 lbs (2,200kg)
Total Approximate Weight	13,563 lbs (6,152kg)	17,441 lbs (7,911kg)	17,944 lbs (8,162kg)
Series II Weights	Series 1 weights are shown above; add 920 lbs (417kg) to the pedestal to achieve Series II detach boom weights.		

*Measured from bottom of pedestal for MX booms.

STANDARD FEATURES — MX 24/28Z, MX 28/32Z, MX 36/40Z

- Multi-Z boom
- Four-section boom with one-piece slewing head
- 365° rotation
- 5" (125mm) pipeline with PM cast manganese elbows (MX 24/28Z, MX 28/32Z)
- 4.6" (117mm) twin pipe (MX 36/40Z)
- 10' (3m) end hose coupled - one end
- Power beyond for hydraulic jacking
- Combi electric switch box
- Centralized lube location
- Modular Boom Controls (MBC)
- World standard control panel
- Cable remote w/130' (40m) cable
- Emergency stop
- High quality paint - blue and white
- Operational & spare parts manuals

RS 750 Pin Tower Specifications (For MX 24/28Z, MX 28/32Z, MX 34/40Z)

Height (3m) (Freestands up to 80' (24m))	10' (3m)
Height (6m) (Freestands up to 80' (24m))	20' (6m)
Width (Square)	4' (1.22m)
Floor Opening (Square)	4' 6" (1.37m)
Approximate Weight (For 10' (3m) Section, Including Adapter)	10,760 lbs (4,880kg)

Gate and Diversion Valves (Applies to all Placing Boom Models)

Model	Maximum Pressure	Weight
GVM 2/2 Manual Gate Valve	1,885 psi (130 bar)	62 lbs (28kg)
GVHM 2/2 Hydraulic or Manual Gate Valve	1,885 psi (130 bar)	165 lbs (75kg)
DVH 5/2 Hydraulic Diversion Valve	1,885 psi (130 bar)	710 lbs (322kg)
SDVH 3/2 HD Hydraulic Diversion Valve	1,885 psi (130 bar)	836 lbs (380kg)

Reach/Boom MX 43/47Z

Boom Design	Z-Fold
Horizontal Reach	138' 1" (42.09m)
Vertical Reach*	138' 1" (42.09m)
Reach Depth*	105' 0" (32.00m)
Stowed Boom Length	30' 2" (9.35m)

Boom Sections

1 st Section	29' 2" (8.89m)
2 nd Section	25' 11" (7.90m)
3 rd Section	24' 7" (7.49m)
4 th Section	27' 3" (8.31m)
5 th Section	27' 11" (8.51m)

Boom Articulation

1 st Section	91°
2 nd Section	181°
3 rd Section	180°
4 th Section	245°
5 th Section	234°

General Specs

Rotation	365°
Pipeline Diameter	5" (125mm)
Power	Diesel-66.78 hp (49.8kw) / 2,600 rpm
Control Systems	Radio-Cable-Manual

Weights

Boom Weight	28,660 lbs (13,000kg)
Pedestal Weight	8,000 lbs (3,629kg)
Total Approximate Weight	36,660 lbs (16,629kg)

STANDARD FEATURES — MX 43/47Z

- Z-Fold boom
- Five-section boom with one-piece slewing head
- 365° rotation
- 5" (125mm) pipeline with PM cast manganese elbows
- 10' (3m) end hose coupled - one end
- Combi electric switch box
- Grouped lube location
- Gravity hook
- Modular Boom Controls (MBC)
- World standard control panel
- Cable remote w/130' (40m) cable
- Emergency stop
- High quality paint - blue and white
- Operational & spare parts manuals

ADDITIONAL COMPONENTS FOR A COMPLETE SYSTEMS APPROACH

As a specialist in concrete and material placing equipment, Putzmeister offers additional components – everything your placing system needs to help you get the job done on time, and on budget.

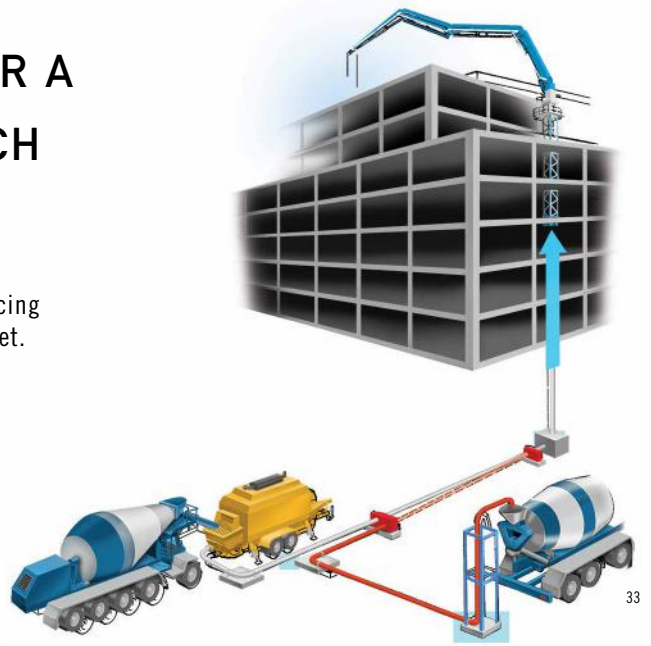

GATE AND DIVERSION VALVES

Gate valves and hydraulic diversion valves are completely leak-proof to meet modern pipeline requirements, while hydraulic diversion valves are also ideal for use with two or more delivery lines.



GVM 2/2



GVHM 2/2

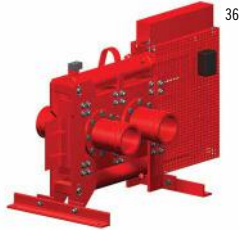

DVH 5/2



SDVH 3/2

BOOM PIPES

Wear-resistant boom pipes, reducers and pipe components from Putzmeister Pipe Technology deliver strength and durability throughout the pipeline.



39

RV 0, RV 7, RV 10, RV 12 AND RV 13 DECK PLACERS

A cost-effective solution for placing concrete when large surfaces obstruct a truck-mounted pump or other placing challenges arise. Putzmeister deck placers feature a boom radius up to 41 ft. (12.6m). Manually operated, the deck placers can be maneuvered into tight areas with a 360° articulating boom. Large areas up to 4,860 sq. ft. (450m²) can be covered from just one setup location. Lightweight and compact.



40

BSA TRAILER PUMPS

Putzmeister BSA High Pressure, High Performance Trailer Pumps offer smooth and reliable pumping with superior durability. The unbeatable flexibility is exceptionally convenient.

PLACING SYSTEMS

ADVANTAGES

- Project support from start to finish
- Highest reach above upper wedge point
- Square tower with modular design
- Simple bracing with vertical support
- Versatile pedestal
- Move entire system in under 10 minutes
- Highest freestanding heights
- No counterweight on booms
- Spacious platform
- Lightweight booms
- Multiple mounting and climbing configuration options



Not all parts are created equal. Putzmeister offers longer lasting, better performing parts under increased wear conditions. Our in-stock inventory includes more than 20,000 parts totaling more than \$40 million dollars. This means greater savings and less downtime.

CUSTOMER SUPPORT AND SERVICE

Count on 24/7 support from Putzmeister's highly trained technical support team to keep your equipment operating smoothly.

Authorized Distributor

CanCrete

Canada's Exclusive Putzmeister Dealer

Toronto: 1810 Meyerside Dr., Mississauga, ON L5T 1B4

416.749.2843

Montreal: 1855 Rue Cunard, Laval, QC H7S 2C7

514.884.0076

Fax: 647.776.3122

sales@concrete.ca

www.concrete.ca

CT 4524A US



© Putzmeister America, Inc. 2015
Printed in the USA (1.51501)

Putzmeister

Putzmeister America, Inc.
1733 90th Street
Sturtevant, WI 53177 USA

Phone (262) 886-3200
Toll-free (800) 884-7210
Fax (262) 884-6338

PutzmeisterAmerica.com

pmr@putzam.com